

- Models
- Modèles
- Modelos



Modelli 2020







 La marque Blucamp - dès 20 ans - est synonyme de fiabilité et de confort - est aussi une garantie de qualité! En effet - chaque modèle vante un véhicule de base avec le meilleur équipement - un aménagement intérieur richement meublé et accueillant - en plus d'un design élégant et de la grande habitabilité traditionnelle Blucamp. Cette nouvelle flotte qui allie qualité et d'innovation - vous garantira des vacances en toute sécurité et confort. Voici la raison pour choisir Blucamp: la certitude de voyager en première classe!

 La marca Blucamp - de 20 años - es sinónimo de fiabilidad y confort - además de ser ¡una garantía de alta calidad! De hecho - cada modelo se jacta de que el vehículo está con el mejor equipo - un diseño interior ricamente amueblado y acogedor - además de un diseño elegante y la tradicional gran habitabilidad Blucamp. Esta nueva flota que combina calidad y innovación - le garantiza unas vacaciones seguras y cómodas. Esta es la razón de elegir Blucamp ¡la certeza de viajar en primera clase!



 Il marchio Blucamp - da ben 20 anni è ormai sinonimo di affidabilità e comfort - oltre che garanzia di alta qualità! Ogni modello vanta infatti meccaniche con le migliori dotazioni e allestimenti interni ricchi e accoglienti che vanno a sommarsi all'eleganza del design e all'ottima abitabilità che da sempre contraddistinguono Blucamp. Questa nuova flotta - felice connubio tra qualità e innovazione - vi garantirà vacanze sicure e confortevoli... Ecco perché scegliere Blucamp: la certezza di viaggiare in prima classe!

 Blucamp brand - from 20 years - it is a synonym of reliability and comfort - in addition to be a guarantee of high quality! In fact - each model vaunts a base vehicle with the best equipment - a richly furnished and welcoming internal layout in addition to an elegant design and Blucamp's traditional great roominess. This new fleet which combines quality and innovation - will guarantee you secure and comfortable holidays. This is the reason to choose Blucamp: the certainty of travelling first class!



... e il viaggio può cominciare.



**OPTIMIST**  
100/100 MAX



599 cm



3+1 (5+1-MAX)



4



4



garage



5



5



5



697 cm



**FLY** 25 S



FLY 27 S

- 
- 687 cm
- 5
- 5
- 5
- garage

- garage
- 6
- 7
- 6+1
- 730 cm
- 

FLY 71



**SUPER FLY** 526





*free*  
**SKY Free**



712 cm



4



4



4

Standard

Optional

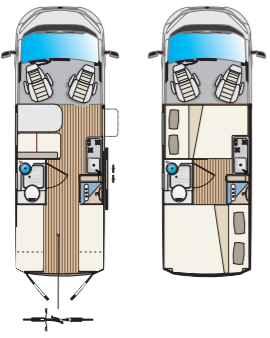
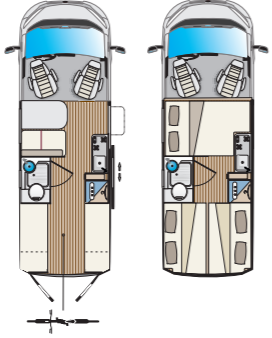
| <b>OPTIMIST</b><br>100/100 max  |   |
|--|---|
| FURGONATI - VANS - FURGONS - FURGONETAS  |   |
|                                 |  |
| <b>OPTIMIST 100</b>  | <b>OPTIMIST 100 MAX</b>   |
| 599x205x266 cm   | 599x205x266 cm  |
| 4  | 4   |
| 3+1  | 5+1   |

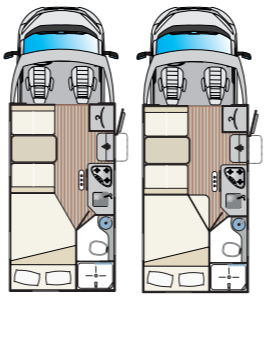
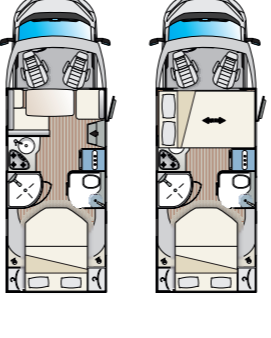
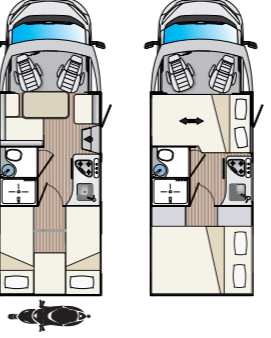
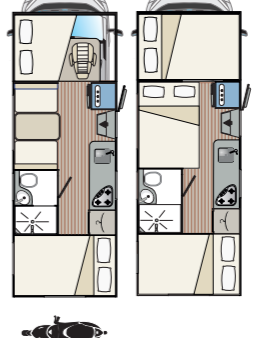
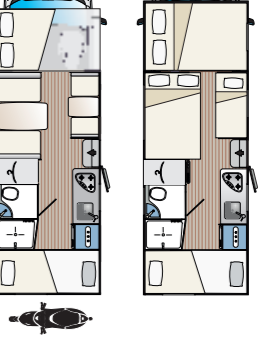
| <b>FLY</b>  |   |   |   |   |
|--|---|---|---|---|
| PROFILATI - NON CABOVER MODELS - PROFILÉS - PERFILES   |   |   |   |   |
|             |  |  |  |  |
| <b>FLY 20 S</b>  | <b>FLY 25 S</b>   | <b>FLY 27 S</b>   | <b>FLY 50 G</b>   | <b>FLY 71</b>   |
| 648x230x294 cm   | 697x230x294 cm  | 687x230x294 cm  | 715x230x305 cm  | 730x230x305 cm  |
| 6  | 5   | 5   | 6   | 7   |
| 6  | 5   | 5   | 6   | 6+1   |



\* **Dotazioni OPTIMIST** - Aria condizionata cabina - Cruise control - ABS - Airbag passeggero - ESP - Radio CD DAB - Oblo panoramico - Chiusura centralizzata - Vernice 'Aluminium Grey' - Sedili regolabili con bracciolo.

\* **OPTIMIST standard equipment** - Air conditioning in the cabin - Cruise control - ABS - Passenger's airbag - ESP - Radio CD DAB - Panoramic Porthole - Central locking system - 'Aluminium Grey' varnished - Adjustable seats with armrest.

\* **OPTIMIST équipement de série** - Climatisation cabine - Cruise control - ABS - Airbag passager - ESP - Radio CD DAB - Hublot panoramique - Fermeture centralisée - Peinture 'Aluminium Grey' - Sièges ajustables avec accoudoir.

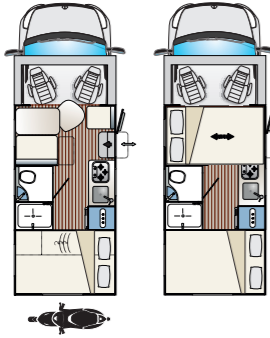
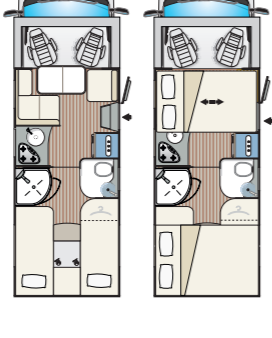
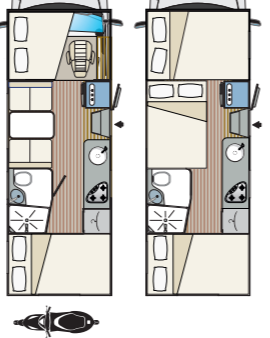
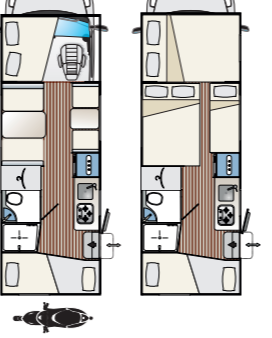
\* **Equipamiento de serie OPTIMIST** - Climatización cabina - Control de crucero - ABS - Airbag paajero - ESP - Radio CD DAB - Ojo de buey panoramico - Cierre centralizado - Pintura 'Aluminium Grey' - Asientos ajustable con apoyabrazos.

| <b>SUPER FLY</b>  |   |  |   |
|--|---|--|---|
| PROFILATI - NON CABOVER MODELS - PROFILÉS - PERFILES   |   |  |   |
|                     |  |  |  |
| <b>SUPER FLY 522</b>   | <b>SUPER FLY 526</b>  | <b>SUPER FLY 650</b>   | <b>SUPER FLY 671</b>  |
| 681x230x294 cm   | 748x230x294 cm  | 732x230x306 cm   | 748x230x306 cm  |
| 5  | 5   | 6  | 7   |
| 5  | 5   | 6  | 7   |

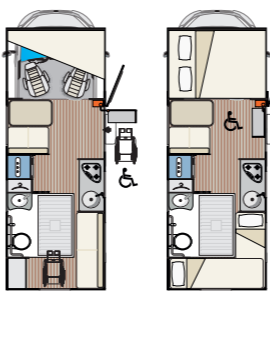
| <br><b>free</b>  |
|--|
|   |
| <b>SKY FREE*</b>   |
| 712x230x310 cm   |
| 4  |
| 4  |



AUTOCARAVAN SENZA BARRIERE - BARRIER-FREE MOTORHOME  
 CAMPING CAR SANS BARRIÈRES - AUTOCARAVANA SIN BARRERAS

\* **SKY Free**

Stesse dotazioni della gamma FLY con aggiunta del Sollevatore HANDYTECH HELP C-6 portata 200 kg e l'esclusione della porta con zanzariera.

\* **SKY Free**

Same equipment of the FLY models with in addition HANDYTECH HELP C-6 lift 200 kg maximum capacity. Not present Entrance Door with mosquito net.

\* **SKY Free**

Même équipement de série que la gamme FLY avec en plus l'élevateur HANDYTECH HELP C-6 poids max. Hissable 200 kg et pas la Porte avec moustiquaire.

\* **SKY Free**

Mismo equipamiento de serie de la gama FLY mas el elevador HANDYTECH HELP C-6 peso permitido 200 kg y no tiene la puerta con mosquitera.

# FLY

## Dotazioni di serie per i modelli FLY

Aria condizionata cabina - Cruise control - ABS / ESP - Carreggiata allargata - Airbag passeggero - Chiusura centralizzata cabina - Specchietti elettrici - Presa USB - Sedili regolabili con bracciolo - Ruota di scorta - Letti basculanti elettrici sui profilati - Radio CD DAB (\*\*) - Fodere sedili cabina (\*\*) - Porta doccia rigida (\*\*) - Antifurto (\*\*) - Porta con zanzariera (\*\*) - Rete protezione letti mansarda e castello (\*\*) - Frigo 141 lt (dove possibile tecnicamente) (\*\*) - Predisposizione pannello solare (\*\*) - Letto matrimoniale posteriore sollevabile manualmente (\*\*).

## Standard equipment for FLY models

Air conditioning in the cabin - Cruise control - ABS / ESP - Enlarged carriageway - Passenger's airbag - Central locking system - Electric windows - USB socket - Adjustable seats with armrest - Spare wheel - Electric drop-down bed on semi-integrated models - Radio CD DAB (\*\*) - Cab seats covers (\*\*) - Rigid shower door (\*\*) - Alarm (\*\*) - Entrance door with mosquito net (\*\*) - Safety net for alcove and bunk beds (\*\*) - Fridge 141 lt (where technically permitted) (\*\*) - Solar panel predisposition (\*\*) - Manually adjustable rear double bed (\*\*).

## L'équipement de série pour les modèles de FLY

Climatisation cabine - Régulateur de vitesse - ABS / ESP - Voie élargie - Airbag passager - Fermeture centralisée - Vitres électriques - Prise USB - Sièges ajustables avec accoudoir Roue de secours - Lits pavillon électriques sur les profilés - Radio CD DAB (\*\*) - Housses des sièges cabine (\*\*) - Porte de la douche rigide (\*\*) - Antivol (\*\*) - Porte avec moustiquaire (\*\*) - Filet de protection lits capucine et superposés (\*\*) - Frigo 141 lt (où techniquement possible) (\*\*) - Predisposition panneau solaire (\*\*) - Lit double arrière ajustable manuellement (\*\*).

## Equipamiento de serie modelos FLY

Climatización cabina - Control de crucero - ABS / ESP - Carretera ampliada - Airbag paajero - Cierre centralizado - Elevalunas eléctricos - Puerto USB - Asientos ajustable con apoyabrazos - Rueda de repuestos - Cama basculante delantera en las perfiladas - Radio CD DAB (\*\*) - Fundas asientos cabina (\*\*) - Puerta rigida de la ducha (\*\*) - Alarma (\*\*) - Puerta con mosquitera (\*\*) - Red de seguridad cama capuchina y litera (\*\*) - Nevera 141 lt (donde técnicamente posible) (\*\*) - Predisposición panel solar (\*\*) - Cama doble posterior elevable manualmente (\*\*).

### (\*\*) Pack Confort (Optional)

Sui modelli FLY Motorizzazione FIAT 140 CV (optional)

### (\*\*) Comfort Pack (Optional)

On FLY models FIAT Engine 140 CV (optional)

### (\*\*) Pack Confort (en option)

Modèles FLY moteur FIAT 140 CV (en option)

### (\*\*) Pack Confort (Opcional)

En los modelos FLY FIAT Engine 140 CV (opcional)

Dati tecnici e caratteristiche dei veicoli riportati nel catalogo sono puramente indicativi. Il costruttore e il distributore non sono pertanto responsabili di eventuali variazioni che - per qualche motivo - dovessero essere apportate nel corso della stagione.

This catalogue is made for general information purposes only. Pictures, texts, technical specs, data and colours, may have been modified in printing. The manufacture reserves the right to change its products without notice. Technical characteristics may vary depending on the country. Kindly contact your local dealer for specific details.

# SUPER FLY

## Dotazioni di serie per i modelli SUPERFLY

Aria condizionata cabina - Alzacristalli elettrici - ABS / ESP - Doppio airbag Computer di bordo - Chiusura centralizzata - Cristalli atermici - Specchietti retrovisori elettrici - Autoradio MP3-USB - Sedili regolabili con bracciolo - Fodere sedili cabina (\*\*) - Porta doccia rigida (\*\*) - Antifurto (\*\*) - Porta con zanzariera (\*\*) - Rete protezione letti mansarda e castello (\*\*) - Frigo 145 lt (dove possibile tecnicamente) (\*\*) - Predisposizione pannello solare (\*\*) - Letto matrimoniale posteriore sollevabile manualmente (\*\*).

## Standard equipment for SUPERFLY models

Air conditioning in the cabin - Electric windows - ABS / ESP - Double airbag On-board computer - Central locking system - Athermic windows - Electric rearview mirrors - Radio MP3-USB - Adjustable seats with armrest - Cab seats covers (\*\*) - Rigid shower door (\*\*) - Alarm (\*\*) - Entrance door with mosquito net (\*\*) - Safety net for alcove and bunk beds (\*\*) - Fridge 145 lt (where technically permitted) (\*\*) - Solar panel predisposition (\*\*) - Manually adjustable rear double bed (\*\*).

## L'équipement de série pour les modèles de SUPERFLY

Climatisation cabine - Vitres électriques - ABS / ESP - Double airbag - Ordinateur de bord - Fermeture centralisée - Vitres athermiques - Rétroviseurs électriques - Autoradio MP3-USB - Sièges ajustables avec accoudoirs - Housses des sièges cabine (\*\*) - Porte de la douche rigide (\*\*) Antivol (\*\*) - Porte avec moustiquaire (\*\*) - Filet de protection lits capucine et superposés (\*\*) - Frigo 145 lt (où techniquement possible) (\*\*) - Predisposition panneau solaire (\*\*) - Lit double arrière ajustable manuellement (\*\*).

## Equipamiento de serie modelos SUPERFLY

Climatización cabina - Elevalunas eléctricos - ABS / ESP - Doble airbag - Ordenador de a bordo - Cierre centralizado - Elevalunas atermicos - Retrovisores eléctricos - Autoradio MP3-USB - Asientos ajustable con apoyabrazos - Fundas asientos cabina (\*\*) - Puerta rigida de la ducha (\*\*) - Alarma (\*\*) - Puerta con mosquitera (\*\*) - Red de seguridad cama capuchina y litera (\*\*) - Nevera 141 lt (dove possibile tecnicamente) (\*\*) - Predisposición panel solar (\*\*) - Cama doble posterior elevable manualmente (\*\*).



Ce catalogue est exclusivement un exemple d'information. Les images, les textes, les données techniques, les notions et les coloris peuvent avoir subi des variations pendant la réalisation de ce catalogue.

Le constructeur se réserve le droit d'apporter certaines modifications à ses propres produits sans aucun préavis. Les caractéristiques techniques peuvent changer selon les pays. Adressez-vous à votre concessionnaire pour connaître les informations spécifiques.

El presente catálogo posee un uso exclusivamente informativo. Las imágenes, los textos, los datos técnicos, las noticias y los colores pueden haber sufrido variaciones durante la realización de este catálogo.

La empresa se reserva el derecho de efectuar modificaciones en sus propios productos sin previo aviso. Las características técnicas varían de país a país, por lo tanto pídale las informaciones específicas a su concesionario.





... e il viaggio può cominciare.

## Blucamp

Via Divisione Alpina Cuneense, 2  
12040 GENOLA (CN) Italia

 Tel. +39 0172 648140

Fax +39 0172 68781

 [staff@blucamp.com](mailto:staff@blucamp.com)



DEALER



[blucamp.com](http://blucamp.com)



[blurent.com](http://blurent.com)