

GO WITH
THE NATION'S
FAVOURITE



Motorhomes 2022





Welcome to Bailey, The Nation's Favourite.

We've been proudly hitting the road for over 70 years. Along the way, we've built hundreds of thousands of Bailey caravans and motorhomes, each of them made with one thing in mind: creating the perfect holiday.

So, no matter which of our models you choose for your home away from home, comfort, convenience and adventure are built into every one.

GO BAILEY! We can't wait to see you out there.



WHERE NEXT?

Contents

Bailey heritage	02
Build quality	04
Value standards	06
Made in Bristol	08
Tested to the limit	10
Choose your layout	12
Choose your Bailey	14
RANGES	
Autograph	16
Adamo	26
PRIMA accessories	38
Where to buy	40
Bailey Owners Club	41

Bailey by name...

The Bailey story started back in 1948, when Martin Bailey designed and built the very first Bailey caravan in his South Bristol garage. His caravans soon captured the nation's adventurous spirit, and Bailey grew into the thriving, family-run business it still is today.

We've come a long way since those early days, not least in the millions (and millions) of miles covered by people in their Bailey caravans and motorhomes all over the world. With over 70 years of experience behind us, we never stop looking forward, to how we can push the boundaries of engineering and innovation in everything we do. And, like you, we're always plotting our next adventure, of course...

OVER 70 YEARS YOUNG



The Queen's visit

As part of our 65th anniversary celebrations, we were honoured to welcome Her Majesty The Queen and His Royal Highness the late Duke of Edinburgh to South Liberty Lane, to enjoy a tour of our production facility.

Family matters

We're proudly family-run to this day, and one thing hasn't changed a bit since Martin started it all: let's build great motorhomes that are superb value for money and inspire more and more people to Go Bailey!

Because, for us, there are few greater pleasures than getting out there in a Bailey motorhome, with nothing but the open road and good times with friends and family ahead.

The best bit? Everyone's welcome in the Bailey family, even if we haven't got to know you yet.

Here's to the next 70 years of making holidays.

What goes into The Nation's Favourite?

It all started with a simple question: "Is there a better way?" Leisure vehicle design and construction hadn't moved on very much for over 30 years, until we developed Alu-Tech and changed everything.

Alu-Tech is a completely new approach to bodysell construction. Using a unique interlocking aluminium framework to clamp the body panels together, Bailey created a shell that was so much more robust and durable than anything else.

Greater protection against the elements comes from a significant reduction in the number of external joints and fixing points, along with using timber-free components in the upper bodysell panels. Thicker, better-insulated panels, cloaked in impact resistant GRP (Glass Reinforced Plastic), hugely improve the thermal performance of the bodysell, for genuine four-season performance. All this, with no increase in weight or cost.

Turns out, there is a better way.

*Terms and conditions apply.
Please visit baileyofofristol.co.uk/warranties-servicing for more information.

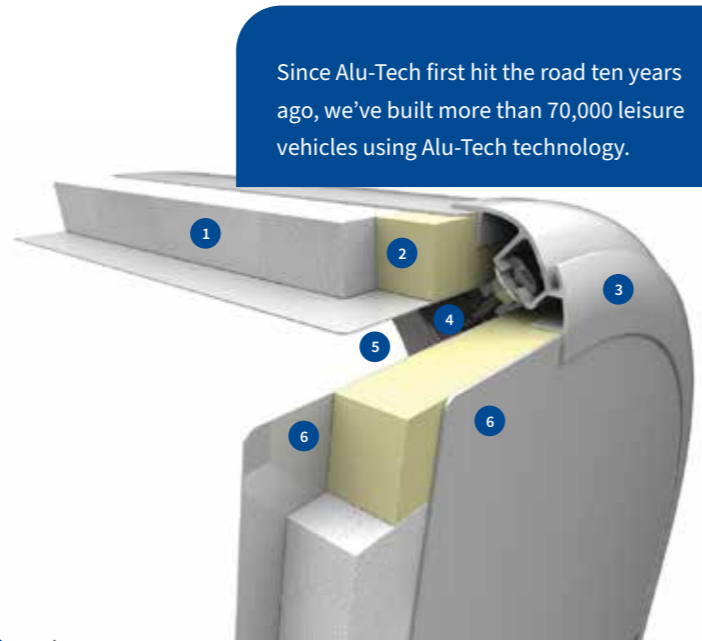

- 1 Polystyrene core
- 2 Composite plastic extrusion
- 3 Alu-Tech rail
- 4 Structural fixing bracket
- 5 Alu-Tech rail insulation
- 6 GRP (Glass reinforced plastic) outer and inner skin



3 year
transferable manufacturer's components warranty*

6 year
transferable bodysell integrity warranty*

Since Alu-Tech first hit the road ten years ago, we've built more than 70,000 leisure vehicles using Alu-Tech technology.



LIGHTWEIGHT DESIGN
Alu-Tech is 10% lighter than conventional construction methods, so they're accessible to a wider range of licence holders and offer larger payloads.

LATEST SAFETY TECHNOLOGY
Anti-lock braking system (ABS), electronic stability programme (ESP) and twin front airbags all fitted as standard.

DESIGNED TO BE DRIVEN
Latest Peugeot Boxer or Ford Transit cab powered by either 165 or 160 bhp engine.

PREMIUM BRANDED TYRES
With TPMS (tyre pressure monitoring system) for superior fuel economy and improved safety.

SEVEN PART BODYSHELL CONSTRUCTION
Built using seven fully laminated panels for enhanced strength and improved thermal performance.

TIMBER-FREE PANEL CONSTRUCTION
Upper bodysell panels are more resistant to the elements, enhancing their longevity.



SUPERIOR THERMAL INSULATION
Thick, fully laminated panels improves thermal performance and allow you to holiday all year round.

INTERLOCKING ALUMINIUM FRAMEWORK
Internal fixings clamp the body panels together, producing a shell of unrivalled strength and rigidity.

PRE-WIRED FOR WIFI
Pre-wired for easy retailer fit of mobile WiFi system.

GRP CLOAKED BODY SHELL
Glass reinforced plastic skin for greater impact resistance and superior thermal insulation.

ON-BOARD WATER SUPPLY AND OFF-GRID POWER
Truma solar panel and 90+ litre fresh and waste water tank

GRP UNDERSIDE PROTECTION
Glass reinforced plastic under skin to floor provides greater resistance against the elements.

CRASH TEST DESIGN FOR ENHANCED SAFETY
Market leading safety courtesy of crash tested floor and furniture design.

We believe in more

We build every Bailey motorhome on one simple principle: with high specifications at superb value for money with no hidden extras.

Simply put, we believe in more – and know that it's the little things that go a long way. Comfort and convenience come as standard in every Bailey, but you'll also find a host of extra features to make you feel at home, wherever you choose to park up.

So it's not just your money that goes further. Our signature build quality means you and your Bailey do too.



...JUST ADD FUN

EUROPEAN COMMUNITY WHOLE VEHICLE TYPE APPROVAL (ECWVTA)
All our motorhomes meet stringent European environmental, safety and security standards.

BRITISH HEALTH AND SAFETY
All our motorhomes comply with British Health and Safety legislation, as certified by the National Caravan Council.

SUPERIOR THERMAL PERFORMANCE
The highest classification of thermal insulation (Grade III of EN1645-I) makes all our motorhomes four-season certified.

OVERCAB SKYVIEW WINDOW
Standard fit on all models, for even more natural light and ventilation.

CAB AIR CONDITIONING AND CRUISE CONTROL
Both fitted as standard, for even more comfort and convenience.

COMPLETE DRIVING COMFORT
Fully adjustable upholstered driver and passenger cab seats with twin arm rests and dual console-mounted cup holders.

USB SOCKETS
Conveniently located throughout.

MARKET-LEADING HEATING SYSTEMS
Truma or Alde central heating and hot water systems (range specific) combine with market-leading Alu-Tech insulation.

INTERNAL LIGHTING SYSTEMS
12v interior LED task and mood lighting systems, with down-lighters and directional spotlights.

WINDOW BLINDS AND FLYSCREENS
Protection and privacy on all windows and rooflights, as well as the main entrance door.

FURNISHINGS AND FLOORS
Premium quality fabrics and superior cushion construction, with practical drop in carpets over durable floor vinyl.

DOMESTIC STYLE REFRIGERATORS
Spacious Dometic or Thetford refrigerators keep your food and drink fresh.

THETFORD COOKING APPLIANCES
Rustle up your favourites with premium Thetford appliances featuring an oven, grill and hob.

BAILEY VALUE
As the Nation's Favourite we like to give you more – meaning more standard specifications for your money and less on the optional extras list.

Made in Bristol

We've been proud to call South Bristol home since 1948. Martin Bailey designed and built the first Bailey caravan in his garage, just a stone's throw from the South Liberty Lane site that now houses our 14.5-acre production facility.

We think of ourselves as one big family. Most of us live nearby and have been part of Bailey for a long time (ten years is the average length of service).

Over 500 hands make every Bailey

From our joiners and electricians, to our designers and fabricators, we have the skills, expertise and experience to build a complex range of caravans and motorhomes, all in the same plant – and all by hand.

We've invested heavily in South Liberty Lane over the last 20 years, including the UK's only mechanised assembly line, so our optimised production process is considered one of the most advanced in Europe. Quantity sits very comfortably with quality.



OVER 500 HANDS
HELP MAKE
EVERY BAILEY



The road ahead

To push UK leisure vehicle manufacturing to the next level, we've completely redeveloped our South Liberty Lane site.

By relocating PRIMA Leisure to North Bristol and our Large Panel Laminating Plant (which makes motorhome sides, ceilings and floors) to North Somerset, we've made space for the purpose-built Replenishment Centre, where we can store the thousands of parts we need to build our caravans and motorhomes. So the future of Bailey is as exciting and innovative as its past.

Tested to the limit

From desert dust to Arctic ice, we put our motorhomes through their paces, so they're at their best on the roads of Great Britain – and beyond.

Good enough simply isn't good enough. It's why we go to such great – and sometimes extreme – lengths to make sure our motorhomes can perform, whatever's thrown their way.

It's only through rigorous testing, that we're satisfied our products are ready for the road. It's why we push our vehicles harder and further, and for longer – and continually set industry performance standards.

Every new range, for example, goes through test conditions that are far in excess of what a motorhome is likely to encounter in its lifetime. Cold chamber testing goes down to -15°C, so we can work with our heating system partners, to get the best possible results in thermal insulation classification. We also put them through accelerated life tests and go to the extent of crash testing our vehicles to ensure your safety is guaranteed.

If something's not up to the job, we go back to the drawing board until it is, before testing it rigorously to make sure it's right. That way, when our products get out there on the road, we know every single one is the best it can be.



 Watch our testing videos online [Go to baileyofbristol.co.uk/tested-to-the-limit](https://www.baileyofbristol.co.uk/tested-to-the-limit)

...MORE THAN UP TO IT

Go anywhere, do everything

Cold chambers and crash tests are one thing, but few things beat getting out there properly.

In 2015, we took two Alu-Tech caravans on a 3,500-mile journey through the Australian Outback. During the two-week trip they stood up to everything the elements could throw at them, proving they could hold their own in even the toughest conditions.

In 2017, we embarked on another marathon endurance test; this time with two caravans and a motorhome, on a 5,000-mile trip to Northern Finland – and well inside the Arctic Circle. Conditions couldn't have been more different than the Red Centre of Australia, but once again the vehicles took everything in their stride.

The successes of these adventures really whet our appetite. So, we decided to embark on a third: 21 countries in 21 days, across two continents – without a rest. From Bristol to Istanbul, we're proud to say the vehicles were more than capable and eager for more – even if we were well in need of a break.



Choose your layout

Before you explore which range and model is right for you, you can narrow down your choice by berth, bed configuration, washroom placement and number of travel seats. You'll see which ranges correspond to your choices in the coloured bars beneath each layout.

2 ↑	4 ↑	4 ↑	4 ↑ 2/4	4 ↑ 2/4	4 ↑	4-6 ↑
End lounge Central washroom	Front lounge End washroom	Twin single beds Central washroom	Corner double bed Corner washroom	Corner double bed End washroom	Island double bed Central washroom	End lounge. Drop down bed Central washroom

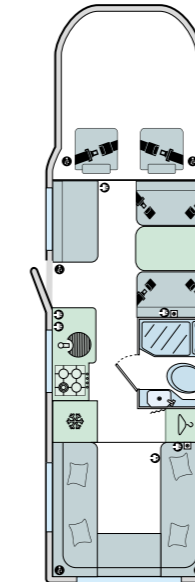
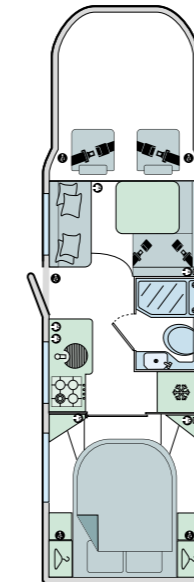
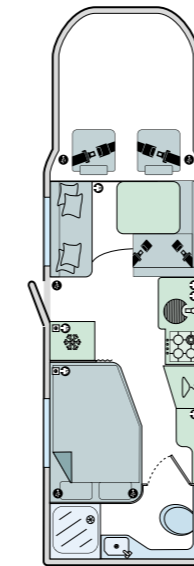
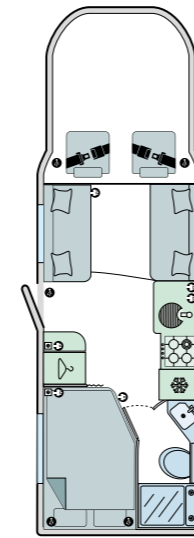
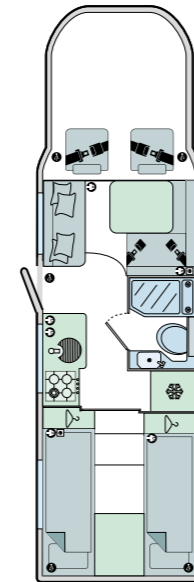
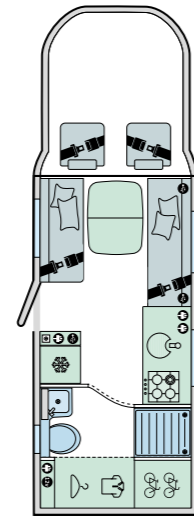
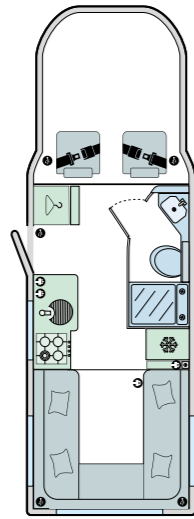

LAYOUTS AVAILABLE IN THE FOLLOWING RANGES:

Autograph p.16

Adamo p.26

Autograph p.16

Autograph p.16

Autograph p.16

Autograph p.16

Autograph p.16

Adamo p.26

Adamo p.26



Travel seats

Find the ranges with the option of either two or four travel seats on pages 14 and 15, then explore the model-specific details later in the brochure.



Choose your Bailey

Now you've decided on berths and travel seats, it's time to choose which motorhome is best for you. You'll find a quick summary of each of the two ranges on the following pages, then you can explore the features of each in much more detail.

2/4/6 Travel Seats



Autograph

p. 16

Style & sophistication

The best of all worlds. The Autograph range makes no compromises, marrying performance with complete comfort, to bring true luxury to even the most ambitious adventures.

Weight up to 4,250kg

4 Travel Seats



ADAMO

p. 26

Smart & spirited

Adamo is the perfect companion to every adventure. Smart design meets seamless practicality across three endlessly flexible layouts, each with exterior garage storage, for whatever you want to throw life's way.

Weight up to 3,500kg

Range comparison



Autograph



ADAMO

	●	●
	●	●
Cab Features	●	●
Anti-lock braking system (ABS)	●	●
Electronic stability program (ESP)	●	●
Fully adjustable upholstered driver and passenger Captain's seats	●	●
DAB Radio with Bluetooth connectivity	●	●
Sat Nav system	●	●
Dometic reversing camera	●	●
Premium brand tyres with pressure sensors	●	●
16" alloy wheels	●	●
AL-KO AMC chassis	●	●
External Features	●	●
Ford Transit skeletal chassis	●	●
Thule Omnistor wind-out awning	●	●
Truma 100 watt solar panel	●	●
Truma 80 watt solar panel	●	●
Exterior gas BBQ point	●	●
High security one-key operation throughout	●	●
Status directional TV aerial	●	●
Exterior 230v socket	●	●
110 Ah premium leisure battery	●	●
93.5 litre external fresh water tank and 94 litre external waste water tank	●	●
100 litre onboard fresh water tank and 100 litre external water tank	●	●
Internal Features	●	●
Alde programmable radiator heating system	●	●
Truma Combi 4E heating system	●	●
Dometic 134 litre tower refrigerator and detachable full width freezer compartment*	●	●
Dometic 10-series 153 litre electronic fridge freezer with universal handed door mechanism*	●	●
Thetford 142 litre combined tower refrigerator with freezer compartment	●	●
Branded 800 watt microwave oven	●	Optional extra
Thetford K-Series combination oven and grill with electric hotplate and three gas burner hob	●	●
USB sockets throughout	●	●

*Model specific



Autograph

Style & sophistication

FIRST-CLASS FREEDOM



Get to know Autograph

The best of all worlds. The Autograph range makes no compromises, marrying performance with complete comfort, to bring true luxury to even the most ambitious adventures.

8 models

2, 4 or 6 travel seats

3,500-4,250kg chassis

Favourite facts

- High-performance Peugeot Boxer 2.2 HDi 165bhp engine
- Dometic reversing camera
- Thule wind-out awning
- Truma 100 watt solar panel for off-grid holidays
- Four-season all weather sustainability with Alde radiator central heating system
- Dometic 153 litre fridge freezer with dual hinged door (model specific)

Packed with luxury features and smart design, the third generation Autograph is our flagship range, where style truly meets substance.

With eight flexible layouts to choose from, there's a model to suit every adventure – no matter who's joining you. Whichever you decide on, your Autograph is full of exquisite styling, elegant curves, polished chrome and sumptuous soft furnishings, not to mention the latest technology.

But the Autograph doesn't just look the part. Under the bonnet is a Peugeot Boxer 2.2 Blue HDi 165bhp engine, with all the performance and power you need, wherever you want to go. Now you just need to decide where.



Autograph

Key features

- 1 New fully adjustable driver and passenger seats with twin upholstered armrests
- 2 Peugeot Sat Nav system
- 3 New 'Cadet Grey' split section loose fit drop in carpets
- 4 New high level storage pockets
- 5 New optional 'Portobello' soft furnishings (cost option)
- 6 Ergonomically shaped rear travel seats (model specific)
- 7 Drop down kitchen worktop extension (model specific)
- 8 New standard 'Farringdon' soft furnishings
- 9 New dual finish 'Cashmere' gloss Italian design overhead curved locker doors



Gallery

Go to baileyofofbristol.co.uk/autograph





Model 74-4



Model 79-4I

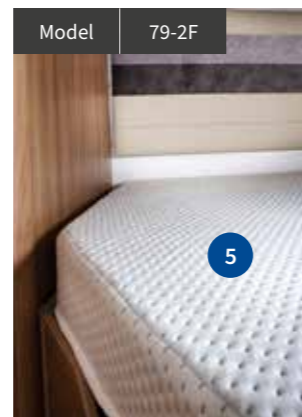

Model 79-2F



Model 69-2

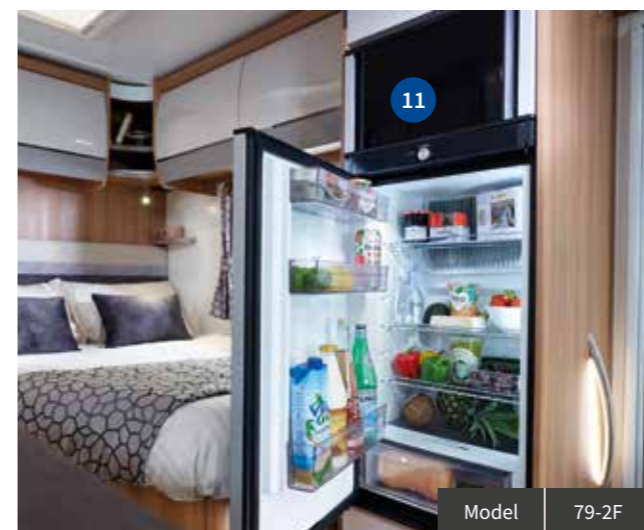

Model 79-2F

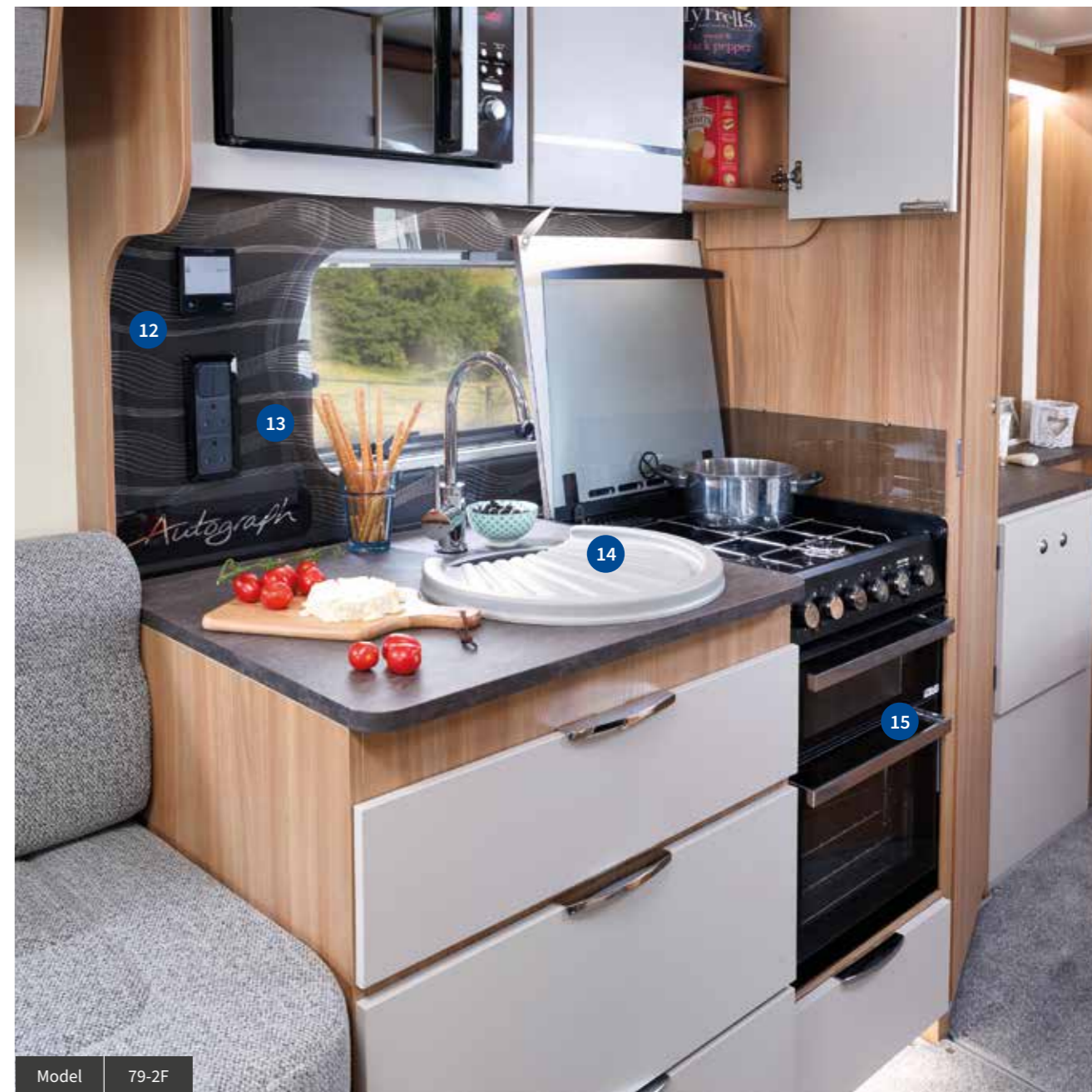

Model 79-2F

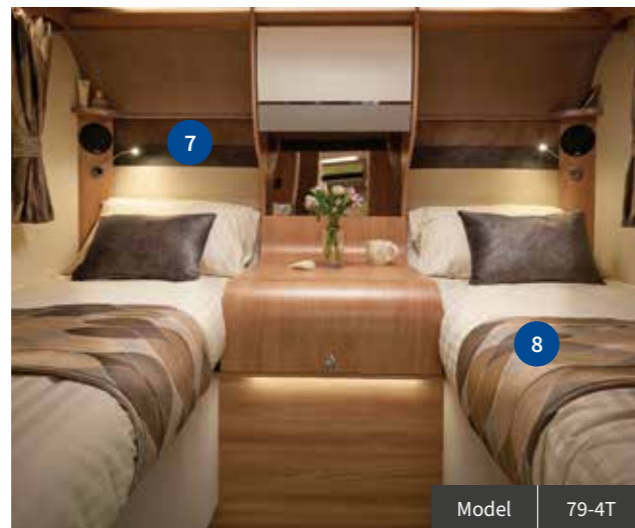

Model 79-4T

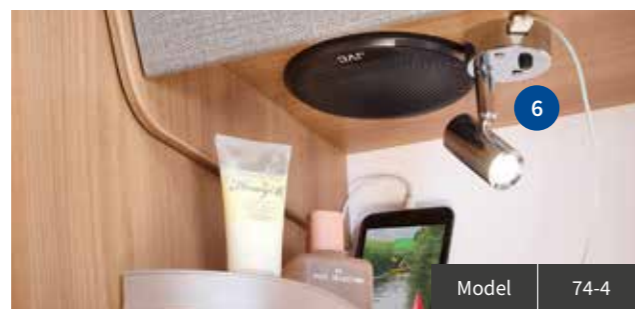

Model 74-4

- 1 Lined shower cubicle with bi-fold partition door and integral lighting
- 2 New diamond cut style 'Graphite' 16" alloy wheels (model specific)
- 3 New Dometic reversing camera
- 4 Through-boot easy access large exterior storage locker (model specific)
- 5 'Honeycore' foam fixed bed mattress construction with stylish fabric covering (model specific)
- 6 New 12v directional spotlights with integral USB sockets in rear bedroom (model specific)
- 7 New full wall headboard
- 8 Bespoke motorhome bedding sets (cost option)
- 9 New feature control panel with USB socket
- 10 New curved corner back rests with removable head rests (model specific)
- 11 New Dometic 10-series 153 litre electronic fridge freezer with universal handed door mechanism (model specific)

- 12 Alde touch screen user-friendly control panel
- 13 New branded Perspex kitchen splashback with chrome detailing
- 14 New stainless steel round kitchen sink with concealed fixings
- 15 New Thetford K-Series combined oven, grill and hob

Specification



Key new features

- **New** 'Graphite' cab with colour coded bumpers and door handles
- **New** diamond cut style 'Graphite' 16" alloy wheels (except 81-6 that has 'Silver' alloy wheels) with premium branded tyres with tyre pressure sensor
- **New** AL-KO low profile AMC chassis
- **New** Thule Omnistor wind-out awning
- **New** drop down hob cover worktop in matching 'Slate Grey' marble finish
- **New** branded Perspex kitchen splashback with chrome detailing
- **New** Dometic 10 series 153 litre electronic fridge freezer with universal handed door mechanism (model specific)
- **New** Dometic 134 litre tower refrigerator (model specific)

Cab

- Peugeot fully compliant Euro 6.2 Boxer Cab supplied with a three-year/100,000 mile warranty and 36 months Peugeot European assist cover
- Peugeot 2.2 Blue HDi (High Pressure Direct Injection) 165bhp engine with 6-speed manual gear box

- Fully specified cab with cruise control, air conditioning, driver and front passenger airbags, electric cab windows and heated wing mirrors
- Remote central locking for cab and habitation door
- Peugeot Sat Nav system
- Dometic reversing camera linked to Peugeot head unit
- High level storage pockets
- Fully adjustable upholstered driver and passenger Captain's seats with twin upholstered armrests and integrated headrests

Exterior features

- High performance GRP skinned 'Dove Grey' and 'Glacier White' Alu-Tech bodyshell (Go to page 4 to find out more about our patented construction)
- Aero-dynamic over cab profile
- Double glazed opening sky view over cab window with blind and internal surround (model specific)
- Aerodynamically profiled double glazed Polyplastic opening windows throughout
- Pleated flyscreens and blinds to all principal windows
- Midi and mini Heki rooflights located throughout the habitation area
- Rear bumper and light pillars with LED road lights
- Rear sequential indicators
- Door step with non-slip mat

- Dometic slimline flush fit habitation door with window, blind and bin plus a gas-strut assisted mechanism for smooth operation and Dometic pleated full length door flyscreen
- Hartal exterior doors featuring flush fit double seals, heavy duty handles, compression locks and retaining clips
- Centrally mounted exterior gas locker compartment
- Underbed storage area (model specific)
- Through-boot easy access large exterior storage on all end-lounge and end-bedroom models
- Co-ordinating graphics scheme

Living room

- Bailey 'Mendip Ash' furniture finish
- Dual finish 'Cashmere' gloss Italian design overhead curved locker doors with 'Grey' textured contrasting stripe
- Structural locker dividers with greater load bearing capacity
- 'Slate Grey' marble finish freestanding table with dedicated storage (model specific)
- 'Slate Grey' marble finish wall-mounted table with dedicated storage (model specific)
- Drop in tables for easy bed make up (model specific)
- Single raised floor for either front or rear lounges
- Drop down flaps on front bed box fascias (model specific)

Entertainment

- Status 550 telescopic directional digital television aerial
- Vision Plus satellite connection provision
- Pre-wired for satellite (Retailer fit)
- TV stations with 230v, 12v and aerial sockets in front and rear (model specific)
- Swivel and tilt TV bracket (model specific)
- Two front and two rear speakers (model specific)
- Pre-wired for WiFi (Retailer fit)

Bedroom

- Fixed single and double beds with aluminium frames and gas strut assisted opening mechanism (model specific)
- Deep-fill bed boxes with enhanced storage capacity (model specific)
- Ceiling-mounted mechanically operated Alu-Line transverse drop down double bed with sprung base (model specific)
- 'Honeycore' foam fixed bed mattress construction and stylish fabric covering (model specific)
- Full wall headboard (model specific)

Kitchen features

- 'Slate Grey' marble finish kitchen worktop laminate
- 'Cashmere' satin finish kitchen drawer fascias with soft-close drawers and handles
- Drop down kitchen worktop extension (model specific)
- Kitchen glass splashguard (model specific)
- Stainless steel round kitchen sink with concealed fixings, swan-neck mixer tap, washing up bowl and drainer
- Branded 800 watt microwave oven
- Thetford K-Series combined oven, grill and hob with electronic ignition and flame failure device
- Thetford dual-fuel hob with electric hotplate and three gas burners

Bathroom features

- 'Slate Grey' marble finish washroom worktop laminate
- Satin finish locker doors and vanity units in washroom
- Lined shower cubicle with bi-fold partition door and integral lighting
- Ceiling-mounted pull down hanging rail on shower hood
- Countertop inset washroom hand basin with ceramic ball mixer tap
- Thetford 12v electric flush toilet with removable cassette on wheels

Electrical

- Truma 100 watt solar panel
- Exterior 230v socket
- Branded 110 ampere/hour premium leisure battery
- 230v power supply with up to six interior sockets
- Twin flexible reading lights with integral USB sockets
- 12v directional spotlights with integral USB sockets in rear bedrooms and rear lounges (model specific)
- Feature control panel with USB socket
- Floor lighting to highlight step
- Additional ambient over locker lighting
- Additional low level task lighting

Heating and plumbing

- Alde Hydronic Compact 3020 programmable radiator heating system with combined water heating
 - Touch screen user-friendly control panel
 - Dual fuel 3.4Kw gas and 3Kw electric power sources
 - Programmable daily timer
 - Panel radiator in washroom
 - Panel radiator in living area (model specific)
- 93.5 litre external insulated fresh water tank with frost heater, baffles and level sensor
- 94 litre external waste water tank with baffles and level sensor (NOT insulated)
- Whale Aqua smart II on-board water pump with Aquasource 'lay flat' filling pipe
- Exterior gas BBQ point
- Pressurised hot and cold fresh water system and self-priming pump

Safety and security

- Crash tested vehicle design featuring reinforced floors and strengthened furniture to enhance passenger safety
- 'Fix and Go' tyre repair kit

Warranty

- Supplied with a six-year transferable bodyshell integrity warranty and a three-year transferable manufacturer's warranty*
- Four-year transferable extension to bodyshell integrity warranty (making ten years in total) and/or three-year transferable extension to manufacturer's warranty (making six years in total) available as cost options*

Optional extras

- **New** optional 'Portobello' soft furnishings
- Bespoke motorhome bedding sets to co-ordinate with soft furnishings (model specific)
- AL-KO chassis mounted spare wheel carrier and spare wheel (steel spare wheel)

*Terms and conditions apply.

Please visit baileيوفbristol.co.uk/warranties-servicing for more information.



For a full list of specifications

Go to baileيوفbristol.co.uk/autograph



69-2

2 床



74-2

2 床



74-4

4 床



79-2F

2 床



79-4F

4 床



79-4I

4 床



79-4T

4 床



81-6

6 床

Designated Travelling Seats	2
Berths	2
Overall Body Length	6.965m/22'10"
Overall Cab Width [^]	2.489m/8'2"
Overall Habitation Width [^]	2.422m/7'11"
Overall Height	2.710m/8'11"
Fitted Awning Length	4m
Tyre Sizes	225/75R 16CP
MTPLM	3500kg
MRO	2993kg
Total User Payload	507kg

Designated Travelling Seats	2
Berths	4
Overall Body Length	7.368m/24'2"
Overall Cab Width [^]	2.489m/8'2"
Overall Habitation Width [^]	2.422m/7'11"
Overall Height	2.710m/8'11"
Fitted Awning Length	4m
Tyre Sizes	225/75R 16CP
MTPLM	3500kg
MRO	3014kg
Total User Payload	486kg

Designated Travelling Seats	4
Berths	4
Overall Body Length	7.368m/24'2"
Overall Cab Width [^]	2.489m/8'2"
Overall Habitation Width [^]	2.422m/7'11"
Overall Height	2.710m/8'11"
Fitted Awning Length	4m
Tyre Sizes	225/75R 16CP
MTPLM	3500kg
MRO	3055kg
Total User Payload	445kg

Designated Travelling Seats	2
Berths	4
Overall Body Length	7.931m/26'0"
Overall Cab Width [^]	2.489m/8'2"
Overall Habitation Width [^]	2.422m/7'11"
Overall Height	2.710m/8'11"
Fitted Awning Length	4.5m
Tyre Sizes	225/75R 16CP
MTPLM	3850kg
MRO	3070kg
Total User Payload	780kg

Designated Travelling Seats	4
Berths	4
Overall Body Length	7.931m/26'0"
Overall Cab Width [^]	2.489m/8'2"
Overall Habitation Width [^]	2.422m/7'11"
Overall Height	2.710m/8'11"
Fitted Awning Length	4.5m
Tyre Sizes	225/75R 16CP
MTPLM	3850kg
MRO	3151kg
Total User Payload	699kg

Designated Travelling Seats	4
Berths	4
Overall Body Length	7.931m/26'0"
Overall Cab Width [^]	2.489m/8'2"
Overall Habitation Width [^]	2.422m/7'11"
Overall Height	2.710m/8'11"
Fitted Awning Length	4.5m
Tyre Sizes	225/75R 16CP
MTPLM	3850kg
MRO	3233kg
Total User Payload	617kg

Designated Travelling Seats	4
Berths	4
Overall Body Length	7.931m/26'0"
Overall Cab Width [^]	2.489m/8'2"
Overall Habitation Width [^]	2.422m/7'11"
Overall Height	2.710m/8'11"
Fitted Awning Length	4.5m
Tyre Sizes	225/75R 16CP
MTPLM	3850kg
MRO	3276kg
Total User Payload	574kg

Designated Travelling Seats	6
Berths	6
Overall Body Length	8.120m/26'8"
Overall Cab Width [^]	2.489m/8'2"
Overall Habitation Width [^]	2.422m/7'11"
Overall Height	2.833m/9'4"
Fitted Awning Length	4.5m
Tyre Sizes	225/75R 16CP
MTPLM	4250kg
MRO	3400kg
Total User Payload	850kg

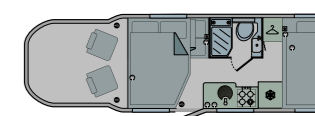
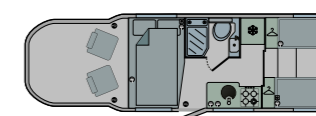
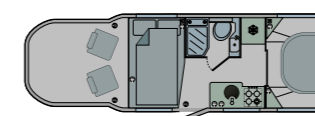
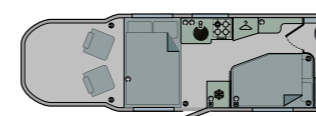
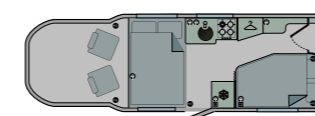
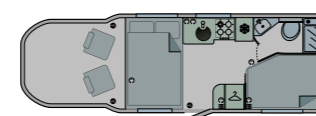
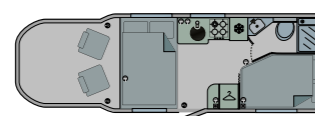
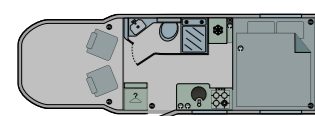
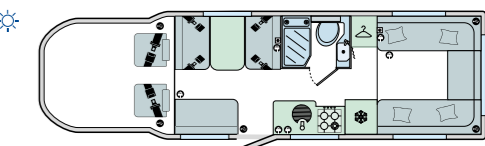
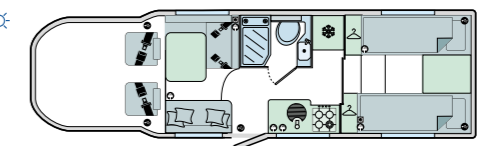
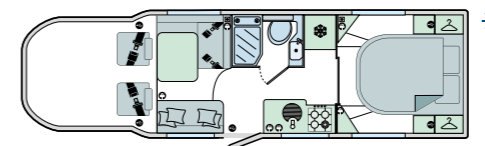
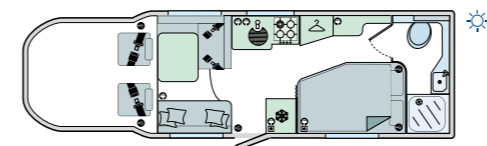
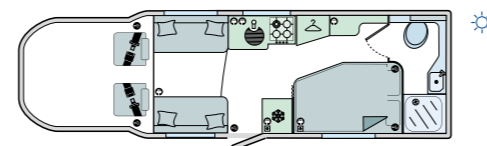
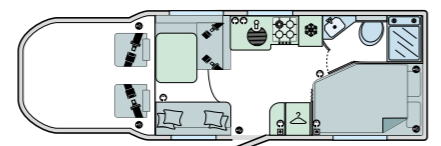
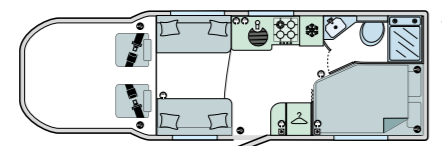
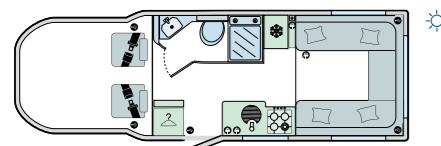

Bed Sizes

Rear Double[†] 2.04m x 1.88m (6'8" x 6'2")

Bed Sizes

Front Double[†] 2.07m x 1.33m (6'10" x 4'4")

Rear Double[†] 1.89m x 1.32m (6'2" x 4'4")

Bed Sizes

Front Double[†] 2.14m x 1.33m (7'0" x 4'4")

Rear Double[†] 1.89m x 1.32m (6'2" x 4'4")

Bed Sizes

Front Double[†] 2.07m x 1.33m (6'9" x 4'4")

Rear Double[†] 1.91m x 1.29m (6'3" x 4'3")

Bed Sizes

Front Double[†] 2.14m x 1.33m (7'0" x 4'4")

Rear Double[†] 1.91m x 1.29m (6'3" x 4'3")

Bed Sizes

Front Double[†] 2.17m x 1.42m (7'1" x 4'8")

Rear Double[†] 1.87m x 1.45m (6'2" x 4'9")

Bed Sizes

Front Double[†] 2.17m x 1.32m (7'1" x 4'4")

N/S Rear Single[†] 1.95m x 0.72m (6'5" x 2'4")

O/S Rear Single[†] 1.86m x 0.72m (6'1" x 2'4")

Bed Sizes

Front Double[†] 1.85m x 1.05m (6'1" x 3'5")

Rear Double[†] 2.05m x 1.84m (6'9" x 6'0")

Drop Down Double^{***†} 2.11m x 1.37m (6'11" x 4'6")

Vehicle weights: the MRO figure is the weight of the unladen motorhome plus an allowance for the driver, 90% of the fuel tank capacity and 'essential habitation equipment'. The MRO is declared with the fresh water tank empty (it is not recommended that you travel with water in the fresh water tank but if you chose to do so then your available payload will reduce accordingly). A tolerance of +/- 5% has also been allowed for in the calculation in the MRO figures.
 Vehicle measurements: [^]Mirrors folded. [†]Inc marker lights. ^{***}Drop down double bed has a maximum load capacity of 200kg. [†]Measured from the widest point. Please refer to baileyofbristol.co.uk for more information.

ADAMO

Smart & spirited

GET UP AND
GONE



Get to know Adamo

Smart design meets seamless practicality across three endlessly flexible layouts, each with exterior garage storage, for whatever you want to throw life's way.

3 models

4 travel seats

3,500kg chassis

Favourite facts

- Ford chassis and cab, with automatic transmission for easy driving
- External onboard garage space, to separate outdoor kit from living space
- Flexi-lounge configures to meet living and travelling needs
- Electric-powered drop-down beds (model specific)
- Four-season capability with Truma Combi heating system and storage for two refillable gas bottles
- 80 watt solar panel for true 'off-grid' adventures

Cleverly designed to be as versatile as possible the Adamo range is ideal for a spontaneous escape or that long planned roadtrip.

Its standard specification offers everything you'd expect from a fully functional and hard-working motorhome. Adamo is built on a Ford chassis and cab, with automatic transmission for an easy drive, and features generous external garage space to transport and store whatever your adventure requires.

And with all three models complete with flexi-lounges and fitted with four travel seats, there is plenty of space for everyone.



Key features

- 1 Fully adjustable upholstered driver and passenger Captain's seats with twin upholstered armrests and integrated headrests
- 2 Flexi lounge featuring twin Aguti convertible travelling seats
- 3 Multi-directional and multi-angled slide out TV bracket (model specific)
- 4 Standard 'Odyssey' soft furnishings supplied with four scatter cushions





Model 69-4



Model 69-4

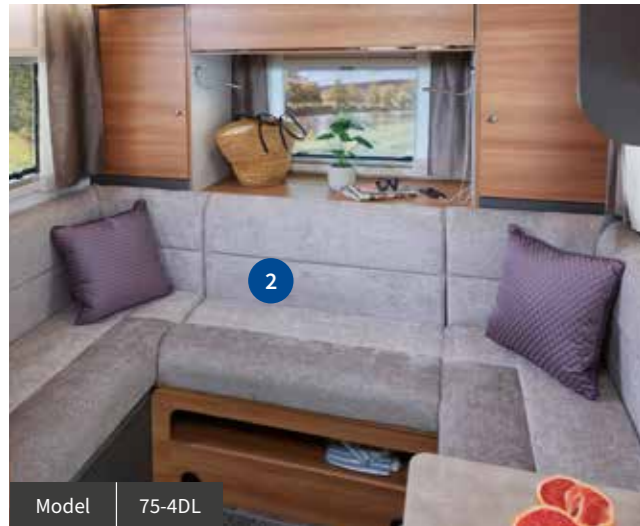

Model 75-4DL

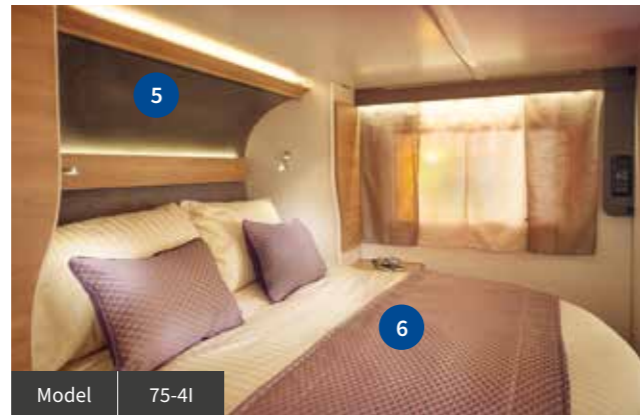

Model 75-4I

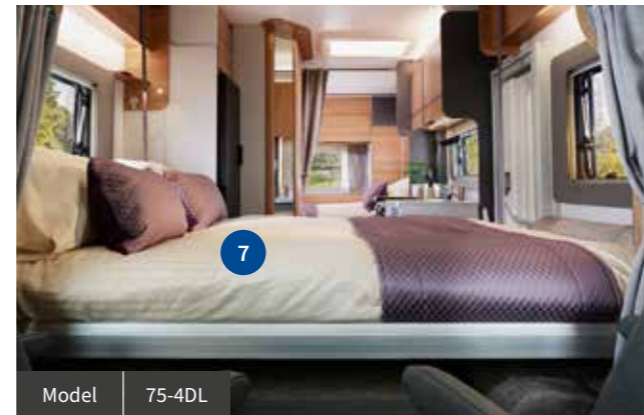

Model 75-4DL



- 1 Thetford 141 litre combined tower refrigerator with freezer compartment
- 2 Rear lounge featuring domestic style sofa seating premium quality fabrics and high density foam filling (model specific)
- 3 Drop down kitchen worktop extension
- 4 Thetford 'K-Series' combined oven, grill and hob with electronic ignition and flame failure device
- 5 Full wall headboard with LED lighting strip (model specific)
- 6 Bespoke motorhome bedding set (cost option)
- 7 Easy to operate electric-powered three position drop down beds (model specific)



Model 75-4I

 **Find your Retailer**
Go to baileyofbristol.co.uk/find-a-retailer



- 8 Ford 2.0 litre 160bhp engine with automatic gearbox
- 9 Vanity cupboard with mirrored door and toothbrush holder
- 10 Countertop mounted washroom hand basin with swan neck ceramic ball mixer tap
- 11 Electrical pedestal table with multi directional swivel 'Nebula Silver' finish top and telescopic leg



Model 75-41

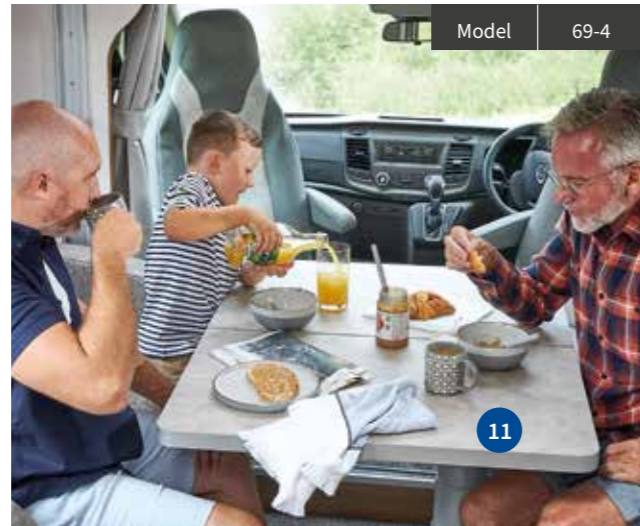

Model 69-4



Model 69-4

- 12 Hanging rail with drainage in garage for wet items (model specific)
- 13 Large garage exterior storage with 230v and 12v socket power supply, up to six lashing rings and heating outlet



Model 69-4



 **Find your Retailer**
Go to baileyofofbristol.co.uk/find-a-retailer

Specification



Cab

- Ford Transit Cab supplied with a three-year/ 100,000 mile warranty and 36 months UK cover
- Ford 2.0 litre 160bhp engine with automatic gearbox
- ‘Metallic Silver’ cab with colour coded bumpers
- ‘Silver’ 16” alloy wheels with premium branded tyres with tyre pressure sensor
- Daytime running lights
- Fully specified cab with cruise control, air conditioning, driver and front passenger airbags, electric cab windows and power heated wing mirrors
- Automatic headlights
- Rain sensing windscreen wipers
- Remote central locking for cab and habitation door
- **New** concertina windscreen and side window blinds
- Integrated radio with Bluetooth connectivity, steering wheel radio controls and cab aerial
- **New** Vision Track reversing camera with mirror mounted monitor
- High level storage pockets
- Fully adjustable upholstered driver and passenger Captain’s seats with twin upholstered armrests and integrated headrests

Exterior features

- High performance GRP skinned ‘Glacier White’ Alu-Tech bodyshell (go to page 4 to find out more about our patented construction)
- Ford Transit skeletal chassis
- **New** AL-KO chassis extensions prepared for optional towbar fitment
- Aero-dynamic over cab profile
- Double glazed opening sky view over cab window with blind and internal surround
- Aerodynamically profiled double glazed Polyplastic opening windows throughout
- Pleated flyscreens and blinds to all principal windows
- Midi and mini Heki rooflights located throughout the habitation area
- Automotive style light clusters in low profile rear bumper
- External dog lashing point
- **New** Hartal flush fit habitation door with window, blind, waste bin, umbrella holder (umbrella not included) and pleated full length door flyscreen
- Door step with non-slip mat
- Hartal exterior storage locker doors featuring double seals, heavy duty handles, compression locks and retaining clips
- Centrally mounted exterior gas locker compartment with space for two 11kg refillable gas bottles or one 11kg and one 6kg refillable gas bottles (model specific)

- Large garage exterior storage featuring:
 - 230v and 12v power supply
 - Heating outlet
 - Up to six floor mounted lashing rings
 - Interior sliding door access into exterior garage storage (model specific)
 - Hanging rail with drainage for wet items (model specific)

Living room

- Flexi-lounge featuring:
 - Twin Aguti convertible travelling seats
 - Electrical pedestal table with multi-directional swivel ‘Nebula Silver’ finish top and telescopic leg
 - Domestic style sofa seating featuring premium quality fabrics and high density foam filling with matching removable arm rest bolsters
- Bailey ‘Mendip Ash’, ‘Lana Grey’ and ‘Anthracite’ furniture finishes
- Locker doors with dark chrome contrasting trim
- Structural locker dividers with greater load bearing capacity
- Entrance storage unit completed with pocket, hooks and illuminated entrance grab handle for ease of access in and out of the motorhome (model specific)
- Standard ‘Odyssey’ soft furnishings supplied with four scatter cushions

- Contrasting fabric window surrounds
- ‘Dove Grey’ split section loose fit drop in carpets

Entertainment

- Status 550 telescopic directional digital television aerial
- Up to two TV stations with 230v, 12v and aerial sockets
- Multi-directional and multi-angled slide out TV bracket (model specific)
- Pre-wired for WiFi (Retailer fit)

Bedroom

- Easy to operate electric-powered three position drop down beds (model specific)
- Fixed bed with slide out aluminium frame (model specific)
- Foam fixed bed mattress construction with stylish fabric covering
- Full wall headboard with LED lighting strip (model specific)
- Sheer panel curtains in bedroom and rear lounge areas (model specific)
- Dual shaped wardrobes to maximise fixed bed size including mattress height storage cubby holes (model specific)

Kitchen features

- ‘Nebula Silver’ finish kitchen worktop laminate
- Drop down kitchen worktop extension
- **New** drop down hob cover
- Splash proof retractable blind for kitchen window with ‘Nebula Silver’ finish window surround
- Stainless steel large round kitchen sink with concealed fixings and mixer tap
- Thetford 141 litre combined tower refrigerator with freezer compartment
- Thetford ‘K-Series’ combined oven, grill and hob with electronic ignition and flame failure device
- Thetford dual-fuel hob with electric hotplate and three gas burners

Bathroom features

- ‘Nebula Silver’ finish washroom worktop laminate with matching splashback
- Vanity cupboard with mirrored door and toothbrush holder
- Large upper wardrobe with hanging rail, shelves and mirrored doors (model specific)
- Gloss white shower cubicle with bi-fold partition door (model specific) and illuminated ‘Carbon’ shower plinth
- Ceiling mounted pull down hanging rail
- Countertop mounted washroom hand basin with swan neck ceramic ball mixer tap

- Thetford 12v electric flush toilet with removable cassette on wheels

Electrical

- Truma 80watt solar panel
- Centrally located 230v inlet, PDU, cab link and solar panel connection box
- 230v power supply with up to four interior sockets
- 12v ambient and task light fittings throughout
- Flexible reading lights with integral USB sockets
- Electrical control panel with USB socket
- Low level lighting to highlight steps

Heating and plumbing

- Truma combi 4E heating system with combined water and room heating
- User-friendly digital control panel with adjustable fan and water boost functions
- Dual fuel 4kw gas and 1.8kw electric power sources
- 100 litre inboard fresh water tank with level sensor
- 100 litre external waste water tank with level sensor
- Whale electric submersible water pump
- Pressurised hot and cold fresh water system and self-priming pump

Safety and security

- Crash tested vehicle design featuring reinforced floors and strengthened furniture to enhance passenger safety
- ‘Fix and Go’ tyre repair kit

Warranty

- Supplied with a six-year transferable bodyshell integrity warranty and a three-year transferable manufacturer’s warranty*
- Four-year transferable extension to bodyshell integrity warranty (making ten years in total) and/or three-year transferable extension to manufacturer’s warranty (making six years in total) available as cost options*
- *Terms and conditions apply. Please visit baileyofofbristol.co.uk/warranties-servicing for more information

*Terms and conditions apply. Please visit baileyofofbristol.co.uk/warranties-servicing for more information.

Optional extras

- Bespoke motorhome bedding set to co-ordinate with soft furnishings (model specific)

Accessories

- Cab Protection Pack – including:
 - Mirror protectors
 - Headlight protectors
 - Rubber floor mats
- Kitchen Pack – including:
 - Washing up bowl
 - Fitted drainer
 - Fitted chopping board
 - Cutlery tray (model specific)
- Microwave Kit - Dometic microwave with matching front panel and base
- Additional bed pack for 75-4DL
 - Rear and front bed kits turn the motorhome into six or eight berths



69-4



75-4I



75-4DL



Designated Travelling Seats	4
Berths	4
Overall Body Length	6.987m/22'11"
Overall Cab Width [^]	2.379m/7'10"
Overall Habitation Width*	2.315m/7'7"
Overall Height	2.849m/9'4"
Tyre Sizes	235/65R 16 C
MTPLM	3500kg
MRO	3090kg
Total User Payload	410kg

Designated Travelling Seats	4
Berths	4
Overall Body Length	7.485m/24'7"
Overall Cab Width [^]	2.379m/7'10"
Overall Habitation Width*	2.315m/7'7"
Overall Height	2.849m/9'4"
Tyre Sizes	235/65R 16 C
MTPLM	3500kg
MRO	3148kg
Total User Payload	352kg

Designated Travelling Seats	4
Berths	4
Overall Body Length	7.485m/24'7"
Overall Cab Width [^]	2.379m/7'10"
Overall Habitation Width*	2.315m/7'7"
Overall Height	2.849m/9'4"
Tyre Sizes	235/65R 16 C
MTPLM	3500kg
MRO	3160kg
Total User Payload	340kg

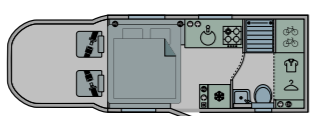
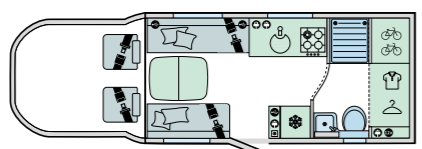

Bed Sizes

Front Double [†]	2.22m x 1.295m (7'3" x 4'3")
Front Drop Down Double [†]	1.84m x 1.56m (6'1" x 5'1")

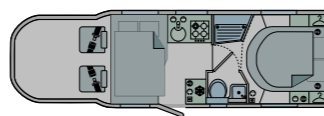
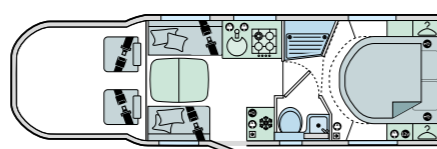

Bed Sizes

Front Double [†]	2.22m x 1.205m (7'3" x 3'11")
Rear Double [†]	1.85m x 1.59m (6'1" x 5'3")

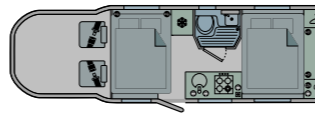
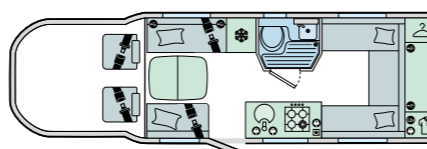

Bed Sizes

Front Drop Down Double [†]	1.84m x 1.35m (6'1" x 4'5")
Rear Drop Down Double [†]	1.84m x 1.35m (6'1" x 4'5")

Vehicle weights: the MRO figure is the weight of the unladen motorhome plus an allowance for the driver, 90% of the fuel tank capacity and 'essential habitation equipment'. The MRO is declared with the fresh water tank empty (it is not recommended that you travel with water in the fresh water tank but if you chose to do so then your available payload will reduce accordingly). A tolerance of +/- 5% has also been allowed for in the calculation in the MRO figures.
Vehicle measurements: [^]Mirrors folded. [†]Inc marker lights. Drop down double bed has a maximum load capacity of 200kg.
[†]Measured from the widest point. Please refer to baileyofbristol.co.uk for more information.



Make the most of your motorhome with accessories and packs made for the Adamo by PRIMA Leisure.

Kitchen pack

Maximise workspace with clever, space-saving kitchen accessories. Pack includes fitted bowl, draining board, stackable chopping board, and cutlery tray (model specific).

Microwave kit

Get quick and convenient hot meals with a Dometic microwave pack, complete with custom-made flush-fitting kit for a discreet and stylish finish.

Living room

Customise your living space with a removable, freestanding table.

Cab protection pack

Keep your cab looking like new with wing-mirror protectors, headlight protectors and fitted rubber mats.

Discover 25,000+ Bailey parts and accessories available through primaleisure.com or through your local Bailey Retailer.



Compare Adamo online
Go to baileyofbristol.co.uk/compare-adamo



The home of Bailey Parts

Exceptional aftersales and accessories

Once you're the proud owner of a Bailey motorhome, we want you to get the very best out of it. So, whether you're adding some finishing touches to really make it your own or tracking down a tricky-to-find part, the PRIMA team of caravanners, motorhomers, campers and outdoor enthusiasts is here to help – and proud to offer you exceptional aftersales service.

With over 25,000 products, the PRIMA online shop has everything you need. Search by vehicle make and model, and browse our expanded category range. In-stock items are dispatched on the same day with thousands of original parts available to order.

We look forward to helping you 'Go Bailey'.



25,000+
Products available to browse

Shop 24 hours a day
7 days a week

Technical team available to help

Deliver directly to you while on holiday (UK only)

Genuine OEM parts and quality accessories

Discover more at primaleisure.com

Where to buy your Bailey

The next step is to find out a little bit more. We have a network of approved Retailers across the country, who we choose to work with because of their expertise. And, like us, they love to get out there and Go Bailey! themselves.

Once you've found your Retailer, you can explore the ranges and models first-hand, along with pre-owned Bailey motorhomes.* Book a test drive and find out which one is 'the one'. The Retailer will be on hand to guide you through your decision and will be happy to talk through finance options, if you need them.

The Bailey warranty

Your new Bailey comes with the peace of mind of our manufacturer's warranty. Your motorhome's bodyshell is covered with a six-year integrity warranty, while other parts and components are covered for up to three years.**

*Subject to availability.
**Terms and conditions apply. Please refer to baileyofofbristol.co.uk for more details.



 Find your Retailer Go to baileyofofbristol.co.uk/find-a-retailer

JOIN THE CLUB



Bailey Owners Club

Once you're out on the road with your Bailey, you're already part of an exclusive club. So why not go one step further and join the real thing?

The Bailey Owners Club is here to help you get the most from your Bailey caravan or motorhome. Completely independent from Bailey of Bristol, there are members all over the world – and there's even a 'Little Bees' club for younger caravanners and motorhomers.

Membership is full of benefits. You'll be invited to weekend events and rallies across the UK, often at exclusive venues, while enjoying discounts on longer holidays in the UK and abroad – as well as online discounts at PRIMA Leisure, of course. You'll even have the chance to come and tour the Bailey factory, and meet the people behind Bailey.

 Join the club
Go to baileyofofbristol.co.uk



Join our community



baileyofbristol.co.uk



This brochure does not constitute an offer by Bailey Caravans Ltd (Bailey). Bailey reserves the right to alter specifications and prices as market and supply conditions demand. Your Bailey retailer will confirm all specification details prior to you making your purchasing decision. E. & O. E. Bailey retailers sell our products of their own choice and not as agents of Bailey. Accordingly they have no authority to bind Bailey or to make any representation or undertaking whatsoever on behalf of Bailey. All household items illustrated in this brochure are used to enhance photography and are for display purposes only. They are not supplied with your motorhome. Photographic colour reproduction is subject to the limitations of the production process.
Printed February 2022.

Designed and produced by: saintnicks

Photography: Alan Bond
Gavin Kaps, Osprey Imagery

Photography locations:

Autograph: Bath Caravan Park, Bath, Somerset
www.bathcaravanpark.com
Bath Spa University, Bath, Somerset
www.bathspa.ac.uk
Adamo: Lyndor CL, Hole-in-the-wall, Ross-on-Wye
www.lyndorcl.co.uk

2 Travel Seats



Autograph

69-2 £79,999 |
MTPLM 3500kg

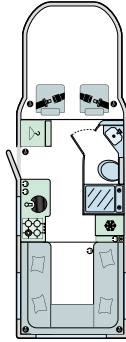

74-2 £82,999 |
MTPLM 3500kg

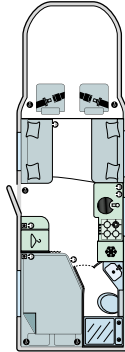

79-2F £83,999 |
MTPLM 3850kg

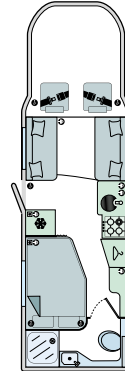

4

79-4I £84,999 |
MTPLM 3850kg

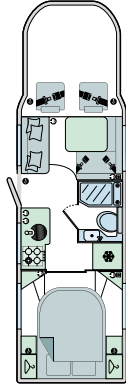

74-4 £83,999 |
MTPLM 3500kg

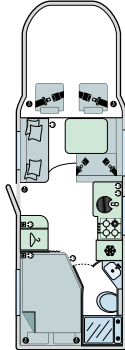

79-4F £84,999 |
MTPLM 3850kg

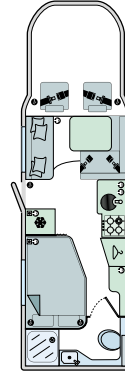

79-4T £84,999 |
MTPLM 3850kg

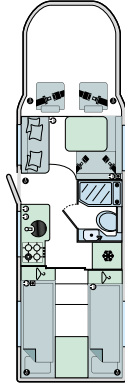

6

81-6 £88,999 |
MTPLM 4250kg

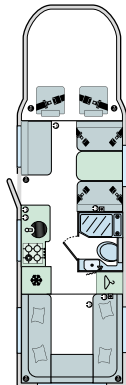

Find your perfect Bailey Go to baileyofbristol.co.uk/compare-motorhomes

4



ADAMO

69-4 £74,499 |
MTPLM 3500kg

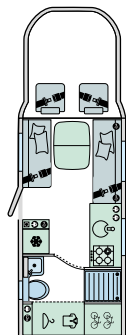

75-4I £75,499 |
MTPLM 3500kg

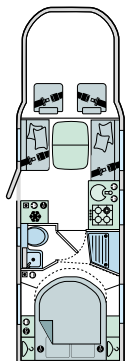

75-4DL £76,499 |
MTPLM 3500kg

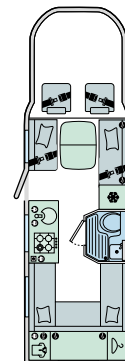



Find your nearest Retailer Go to baileyofbristol.co.uk/find-a-retailer

Autograph

Style & sophistication

69-2		£79,999
74-2		£82,999
74-4		£83,999
79-2F		£83,999
79-4F		£84,999
79-4I		£84,999
79-4T		£84,999
81-6		£88,999
'Portobello' alternative upholstery		£225
AL-KO chassis mounted spare wheel carrier and spare wheel (steel spare wheel)	29kg	£375

ADAMO

Smart & spirited

69-4		£74,499
75-4I		£75,499
75-4DL		£76,499
Adamo accessories available at primaleisure.com		
Cab protection pack	4.6kg	£220
Kitchen pack (model specific)	1.1kg	From £36
Microwave kit with matching front panel and base	15.8kg	£170

Optional extras available in all ranges

Bespoke motorhome bedding sets to co-ordinate with motorhome soft furnishings (model specific)	Up to 7.3kg	From £228
4-year extension to standard 6-year bodyshell integrity warranty (ten years in total)* inc IPT		£265
3-year extension to standard 3-year manufacturers warranty (six years in total)* inc IPT		£849

All prices shown include VAT at 20%.

Autograph: On the road (OTR) price includes a cost of up to £280 for a 12-month road fund licence as well as an additional cost of £1,500 to cover delivery to a Retailer in Great Britain, number plates, first registration fee and VAT at 20%.

Adamo: On the road (OTR) price includes a cost of £280 for a 12-month road fund licence as well as an additional cost of £1,400 to cover delivery to a Retailer in Great Britain, number plates, first registration fee and VAT at 20%.

Price Guarantee: These prices are guaranteed subject to you ordering your motorhome from the earliest production availability and that you take delivery within 14 days of dispatch from the factory.

Optional Extras: Options pricing only applicable on new motorhome orders. Please note that where an option is identified as model specific this means that it is only available on selected models within a range. Please ask your supplying Retailer for more information. *Terms & Conditions apply to the warranty extension schemes.